

► SPECIFICATIONS

# 6 Tonne Front Tip

MACH2060

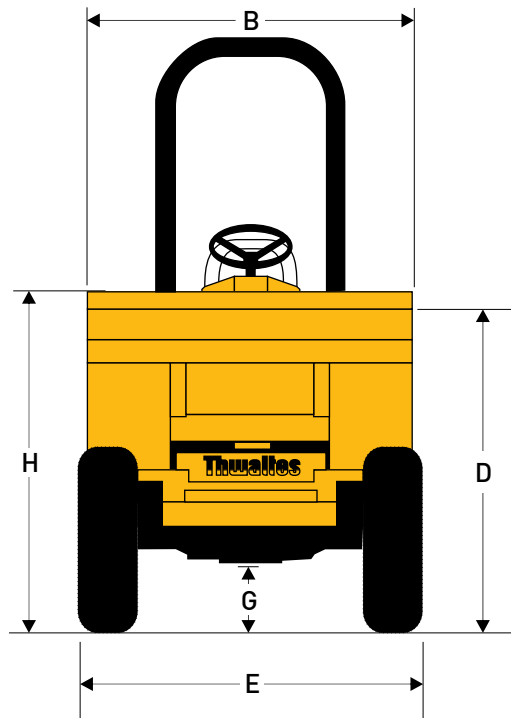
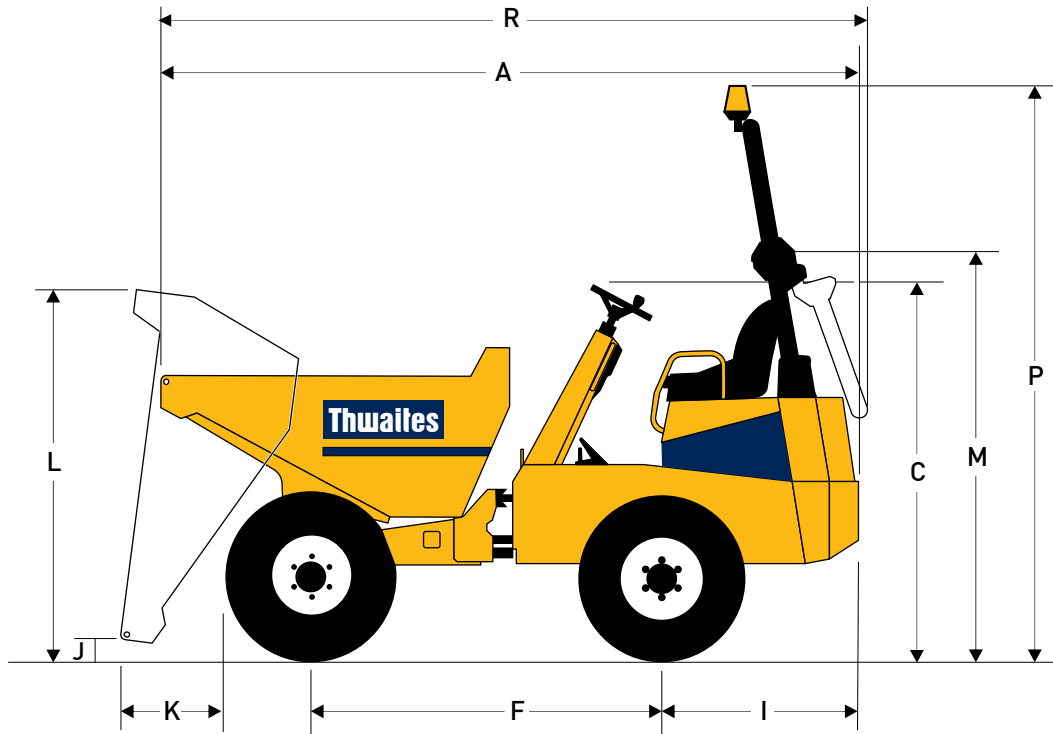

Dimension  
(mm)

A	4475
B	2354
C	2230
D	1610
E	2240
F	2480
G	370
H	1740
I	1235
J	340
K	520
L	2505
M	2230
P	3390
R	4742

## SPECIFICATIONS

# 6 Tonne Front Tip

MACH2060

Capacities	Max safe load	6000kg
	Heaped	3400 litres
	Struck	2525 litres
	Water	1925 litres

### Engine

Deutz TD 3.6 L4 55.4kW/74hp at 2200rpm, water-cooled, 4-cylinder, charged air cooled turbo, electronic controlled fuel injected diesel engine. Powercore air intake filter and stainless steel exhaust system, including after treatment Diesel Oxidisation Catalyst providing conformity to EU Stage IIIB emission regulations. Peak torque 330Nm at 1600 rpm.

### Noise Levels

Operator's ear 84 LpA, airborne sound level 102 LwA

### Transmission

Torque converter four speed forward and reverse Powershuttle transmission with column mounted directional control lever and heavy duty gear driven transfer box.

Speeds	Forward and Reverse	
	1	5.0km/h (3.1 mph)
	2	8.0km/h (5.0 mph)
	3	15.1km/h (9.3 mph)
	4	27.7 km/h (17.2 mph)

Tyres	405/70 x 20
	Track grip tread
	Load/Speed Index 142 A8

### Brakes and Axles

Twin circuit totally enclosed multiplate oil immersed discs, mounted on both axles with automatic adjustment for wear. Hand operated parking brake. Heavy duty axles with epicyclic reduction and fully floating half shafts.

### Kinglink Chassis

Front and rear chassis constructed from deep section folded steel plate, with three point Kinglink giving articulation and oscillation for better stability, traction and extra safety on site. Remote greasing point provided for lubrication of top Kinglink articulation pin.

### Skip

Hydraulically operated, 6 mm steel base plate, fully welded, mouth and sides of skip reinforced with box sections giving greater strength to minimise skip damage. No material traps.

### Seating & Controls

Adjustable suspension seat, fitted with high visibility rigid seat belt with adjustable web, accessible from both sides. Audible warning device for handbrake in "on" position, electric horn, large pedal pads, ignition key, park brake and skip controls ready to hand. Super bright LED warning lights visible from the drivers position for all critical functions.

### Service Access

Lockable three sided cover opens to provide easy access from ground level to engine service points, all located on the same side. Rear chassis panel can be hinged back on retainers. An additional service access door incorporates the battery. Moulded plastic diesel tank and steel hydraulic tank are positioned low in chassis side members, permitting access to the filler caps from ground level.

### Electrics

Engine control unit with shutdown monitoring. Electronic equipment function includes diagnostic port and tri-function hour meter/ fault code reader/ battery volt meter. Fuse & relay panel housed in easy to access position, with all wiring contained in solid sealed conduit and all electrical components water resistant to IP67 rating.

### Steering and Hydraulics

Single gear pump providing hydraulic functions includes priority power steering. Filter mounted on top of the tank accessible from ground level. Hydraulic test point fitted as standard.

Tank Capacities	Fuel	72 litres
	Hydraulic	50 litres

Shipping Cube	24.9 m <sup>3</sup> (with ROPS)
---------------	---------------------------------

Unladen Weight	4200kg
----------------	--------

Clearance Diameter	12.6m
--------------------	-------

Standard Equipment	Towing bracket
	Folding ROPS frame
	Rotary beacon
	Low fuel level warning
	Water in fuel warning
	High visibility rigid seat belt
	Reverse alarm
	Low Brake Fluid warning
Handbrake test switch	

Distributor

# Thwaites

Thwaites Ltd. Leamington Spa, Warwickshire CV32 7NQ, England  
Tel +44 (0)1926 422471 Fax +44 (0)1926 337155  
www.thwaitesdumpers.co.uk



We reserve the right to change all specifications without prior notice.  
Printed in England 02/2017